



# STE53NC50

## N-CHANNEL 500V - 0.070Ω - 53A ISOTOP

### PowerMesh™II MOSFET

TYPE	V <sub>DS</sub>	R <sub>DS(on)</sub>	I <sub>D</sub>
STE53NC50	500V	< 0.08Ω	53 A

- TYPICAL R<sub>DS(on)</sub> = 0.07 Ω
- EXTREMELY HIGH dv/dt CAPABILITY
- 100% AVALANCHE TESTED
- NEW HIGH VOLTAGE BENCHMARK
- GATE CHARGE MINIMIZED

#### DESCRIPTION

The PowerMESH™II is the evolution of the first generation of MESH OVERLAY™. The layout refinements introduced greatly improve the Ron\*area figure of merit while keeping the device at the leading edge for what concerns swithing speed, gate charge and ruggedness.

#### APPLICATIONS

- HIGH CURRENT, HIGH SPEED SWITCHING
- SWITCH MODE POWER SUPPLIES (SMPS)
- DC-AC CONVERTERS FOR WELDING EQUIPMENT AND UNINTERRUPTIBLE POWER SUPPLIES AND MOTOR DRIVER

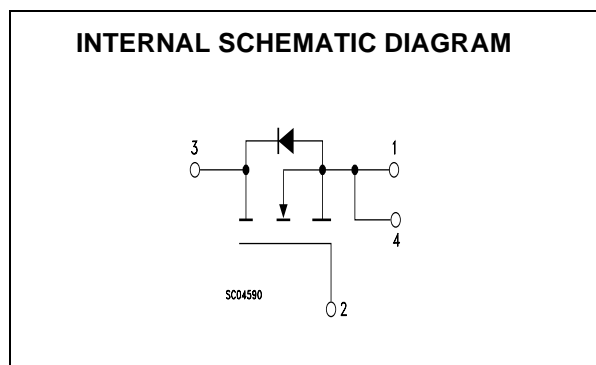
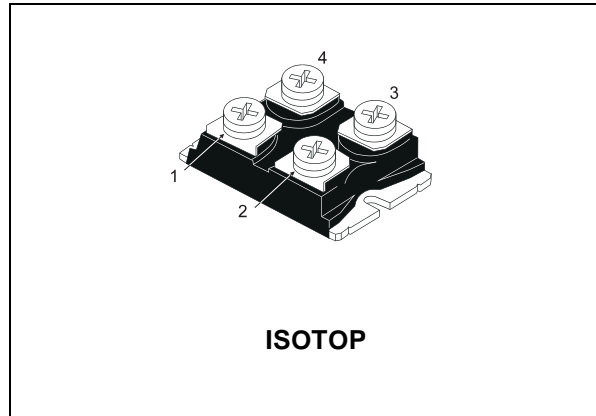

#### ABSOLUTE MAXIMUM RATINGS

Symbol	Parameter	Value	Unit
V <sub>DS</sub>	Drain-source Voltage (V <sub>GS</sub> = 0)	500	V
V <sub>DGR</sub>	Drain-gate Voltage (R <sub>GS</sub> = 20 kΩ)	500	V
V <sub>GS</sub>	Gate- source Voltage	±30	V
I <sub>D</sub>	Drain Current (continuos) at T <sub>C</sub> = 25°C	53	A
I <sub>D</sub>	Drain Current (continuos) at T <sub>C</sub> = 100°C	33	A
I <sub>DM</sub> (•)	Drain Current (pulsed)	212	A
P <sub>TOT</sub>	Total Dissipation at T <sub>C</sub> = 25°C	460	W
	Derating Factor	3.68	W/°C
dv/dt (1)	Peak Diode Recovery voltage slope	3	V/ns
V <sub>ISO</sub>	Insulation Winthstand Voltage (AC-RMS)	2500	V
T <sub>stg</sub>	Storage Temperature	- 65 to 150	°C
T <sub>j</sub>	Max. Operating Junction Temperature	150	°C

(•)Pulse width limited by safe operating area

(1) I<sub>SD</sub> ≤ 53A, di/dt ≤ 100 A/μs, V<sub>DD</sub> ≤ 24V, T<sub>J</sub> ≤ T<sub>JMAX</sub>

## STE53NC50

### THERMAL DATA

Rthj-case	Thermal Resistance Junction-case	Max	0.272	°C/W
Rthc-h	Thermal Resistance Case-heatsink with Conductive Grease Applied		0.05	°C/W

### AVALANCHE CHARACTERISTICS

Symbol	Parameter	Max Value	Unit
I <sub>AR</sub>	Avalanche Current, Repetitive or Not-Repetitive (pulse width limited by T <sub>j</sub> max)	53	A
E <sub>AS</sub>	Single Pulse Avalanche Energy (starting T <sub>j</sub> = 25 °C, I <sub>D</sub> = I <sub>AR</sub> , V <sub>DD</sub> = 50 V)	1043	mJ

### ELECTRICAL CHARACTERISTICS (TCASE = 25 °C UNLESS OTHERWISE SPECIFIED) OFF

Symbol	Parameter	Test Conditions	Min.	Typ.	Max.	Unit
V <sub>(BR)DSS</sub>	Drain-source Breakdown Voltage	I <sub>D</sub> = 250 μA, V <sub>GS</sub> = 0	500			V
I <sub>DSS</sub>	Zero Gate Voltage Drain Current (V <sub>GS</sub> = 0)	V <sub>DS</sub> = Max Rating V <sub>DS</sub> = Max Rating, T <sub>C</sub> = 125 °C			10 100	μA μA
I <sub>GSS</sub>	Gate-body Leakage Current (V <sub>DS</sub> = 0)	V <sub>GS</sub> = ± 30V			±100	nA

### ON (1)

Symbol	Parameter	Test Conditions	Min.	Typ.	Max.	Unit
V <sub>GS(th)</sub>	Gate Threshold Voltage	V <sub>DS</sub> = V <sub>GS</sub> , I <sub>D</sub> = 250μA	2	3	4	V
R <sub>DS(on)</sub>	Static Drain-source On Resistance	V <sub>GS</sub> = 10V, I <sub>D</sub> = 27A		0.07	0.08	Ω

### DYNAMIC

Symbol	Parameter	Test Conditions	Min.	Typ.	Max.	Unit
g <sub>fs</sub> (1)	Forward Transconductance	V <sub>DS</sub> > I <sub>D(on)</sub> × R <sub>DS(on)max</sub> , I <sub>D</sub> = 15 A		42		S
C <sub>iss</sub>	Input Capacitance	V <sub>DS</sub> = 25V, f = 1 MHz, V <sub>GS</sub> = 0		11.2		nF
C <sub>oss</sub>	Output Capacitance			1350		pF
C <sub>rss</sub>	Reverse Transfer Capacitance			115		pF

Note: 1. Pulsed: Pulse duration = 300 μs, duty cycle 1.5 %.

**ELECTRICAL CHARACTERISTICS (CONTINUED)**  
SWITCHING ON

Symbol	Parameter	Test Conditions	Min.	Typ.	Max.	Unit
$t_{d(on)}$	Turn-on Delay Time	$V_{DD} = 250V, I_D = 26.5A$		46		ns
$t_r$	Rise Time	$R_G = 4.7\Omega, V_{GS} = 10V$ (see test circuit, Figure 3)		70		ns
$Q_g$	Total Gate Charge	$V_{DD} = 400V, I_D = 53A,$		310	434	nC
$Q_{gs}$	Gate-Source Charge	$V_{GS} = 10V$		46		nC
$Q_{gd}$	Gate-Drain Charge			150		nC

SWITCHING OFF

Symbol	Parameter	Test Conditions	Min.	Typ.	Max.	Unit
$t_{r(Voff)}$	Off-voltage Rise Time	$V_{DD} = 400V, I_D = 53A,$		45		ns
$t_f$	Fall Time	$R_G = 4.7\Omega, V_{GS} = 10V$ (see test circuit, Figure 5)		38		ns
$t_c$	Cross-over Time			85		ns

SOURCE DRAIN DIODE

Symbol	Parameter	Test Conditions	Min.	Typ.	Max.	Unit
$I_{SD}$	Source-drain Current				53	A
$I_{SDM(2)}$	Source-drain Current (pulsed)				212	A
$V_{SD(1)}$	Forward On Voltage	$I_{SD} = 53A, V_{GS} = 0$			1.6	V
$t_{rr}$	Reverse Recovery Time	$I_{SD} = 53A, di/dt = 100A/\mu s,$		760		ns
$Q_{rr}$	Reverse Recovery Charge	$V_{DD} = 70V, T_j = 150^\circ C$ (see test circuit, Figure 5)		17.86		$\mu C$
$I_{RRM}$	Reverse Recovery Current			47		A

Note: 1. Pulsed: Pulse duration = 300  $\mu s$ , duty cycle 1.5 %.  
2. Pulse width limited by safe operating area.

Safe Operating Area

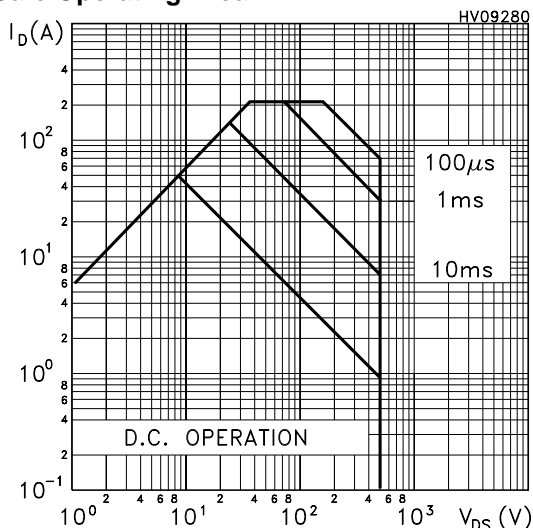

Thermal Impedance

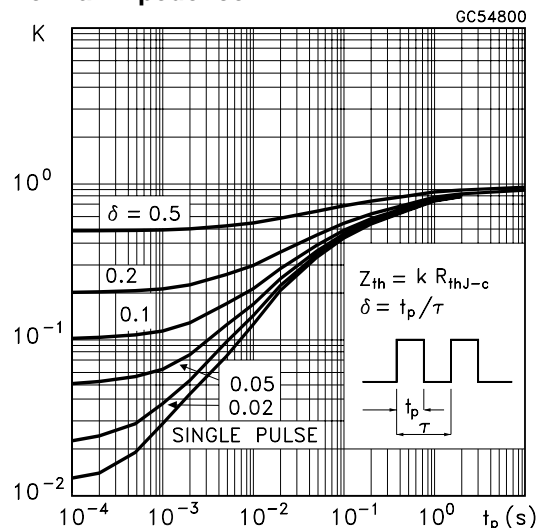

Output Characteristics

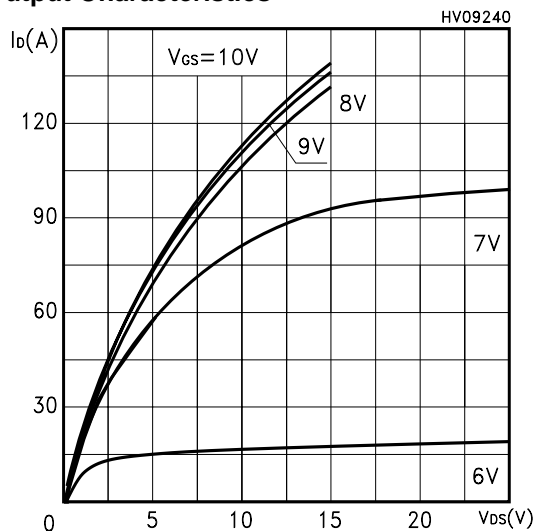

Transfer Characteristics

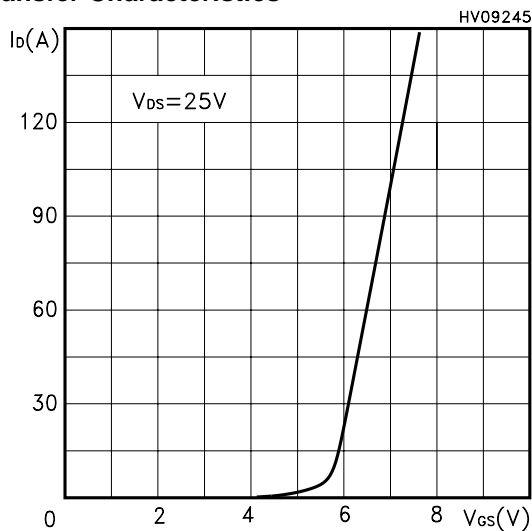

Transconductance

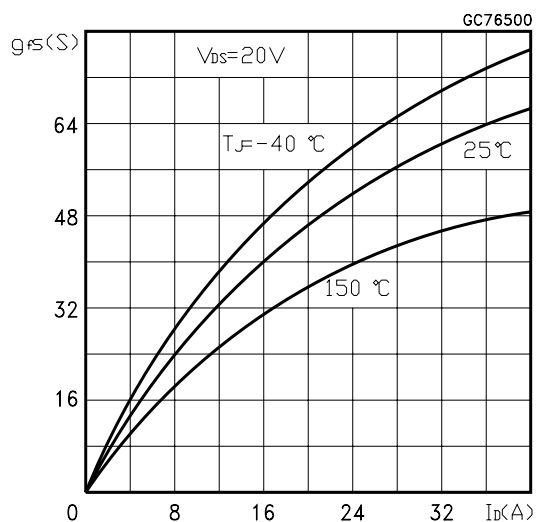

Static Drain-source On Resistance

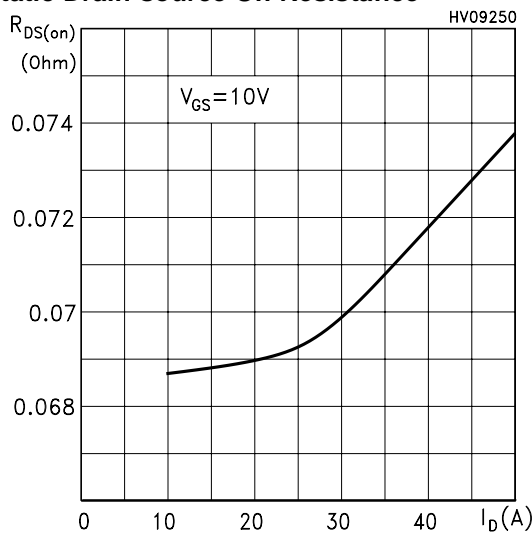

Gate Charge vs Gate-source Voltage

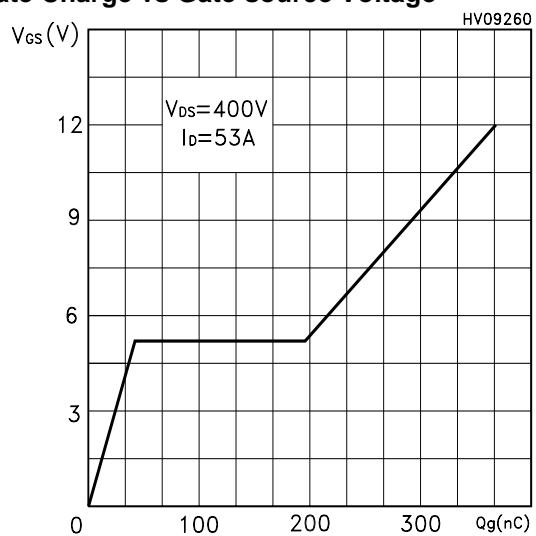

Capacitance Variations

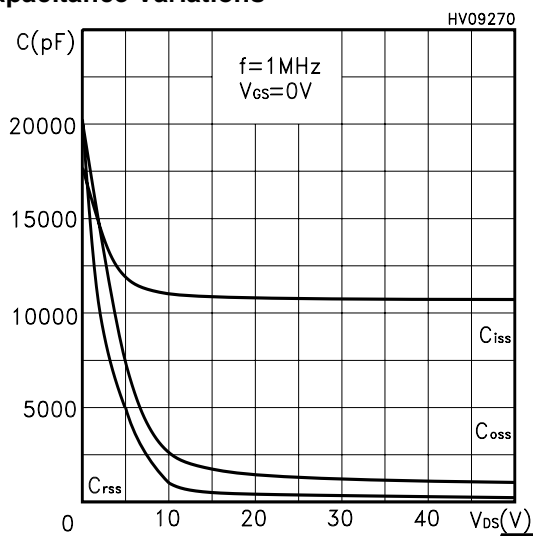

Normalized Gate Threshold Voltage vs Temp.

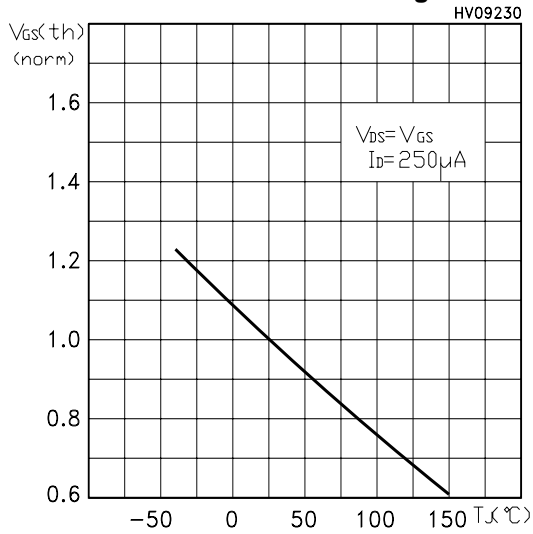

Normalized On Resistance vs Temperature

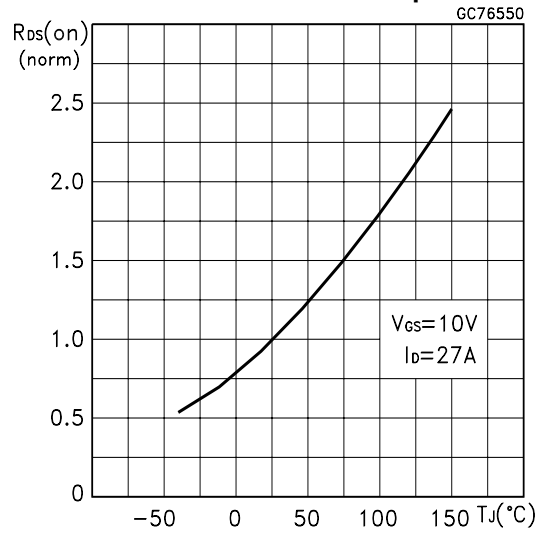

Source-drain Diode Forward Characteristics

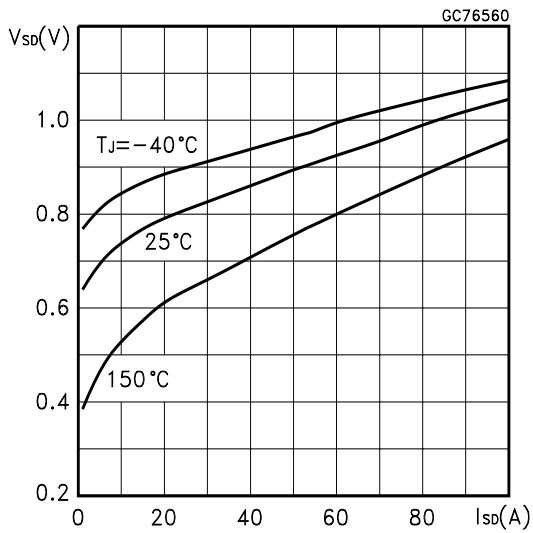

Fig. 1: Unclamped Inductive Load Test Circuit



Fig. 2: Unclamped Inductive Waveform



Fig. 3: Switching Times Test Circuit For Resistive Load



Fig. 4: Gate Charge test Circuit

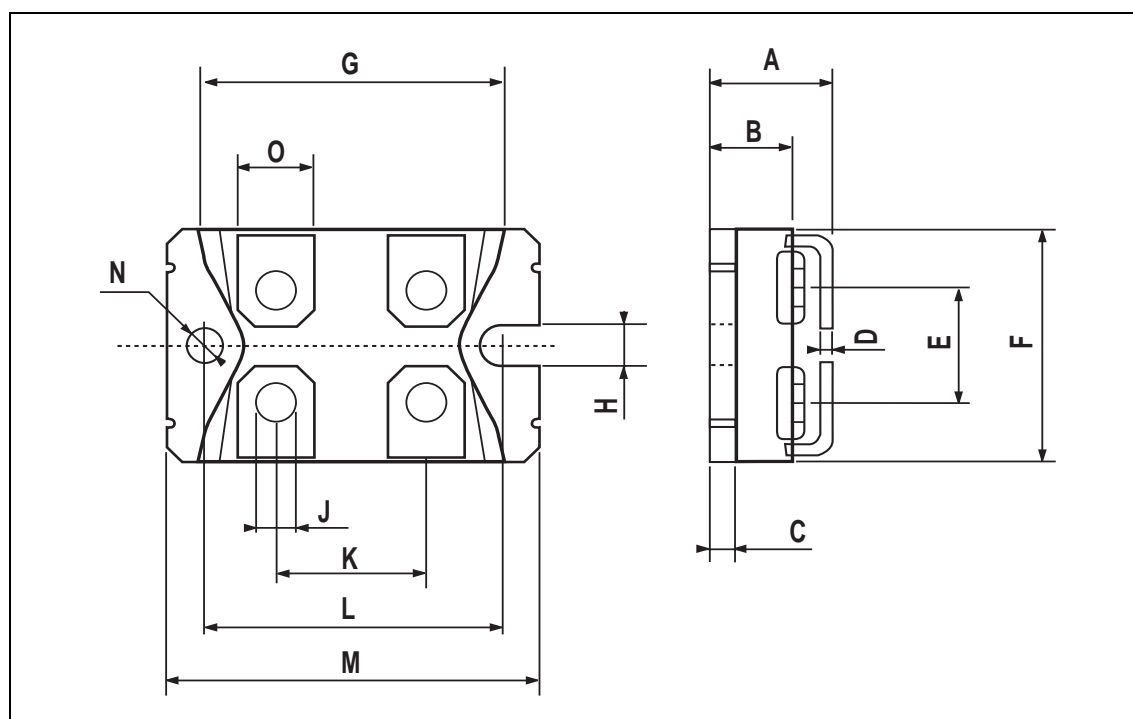

Fig. 5: Test Circuit For Inductive Load Switching And Diode Recovery Times



## ISOTOP MECHANICAL DATA

DIM.	mm			inch		
	MIN.	TYP.	MAX.	MIN.	TYP.	MAX.
A	11.8		12.2	0.466		0.480
B	8.9		9.1	0.350		0.358
C	1.95		2.05	0.076		0.080
D	0.75		0.85	0.029		0.033
E	12.6		12.8	0.496		0.503
F	25.15		25.5	0.990		1.003
G	31.5		31.7	1.240		1.248
H	4			0.157		
J	4.1		4.3	0.161		0.169
K	14.9		15.1	0.586		0.594
L	30.1		30.3	1.185		1.193
M	37.8		38.2	1.488		1.503
N	4			0.157		
O	7.8		8.2	0.307		0.322



Information furnished is believed to be accurate and reliable. However, STMicroelectronics assumes no responsibility for the consequences of use of such information nor for any infringement of patents or other rights of third parties which may result from its use. No license is granted by implication or otherwise under any patent or patent rights of STMicroelectronics. Specifications mentioned in this publication are subject to change without notice. This publication supersedes and replaces all information previously supplied. STMicroelectronics products are not authorized for use as critical components in life support devices or systems without express written approval of STMicroelectronics.

© The ST logo is a registered trademark of STMicroelectronics

© 2002 STMicroelectronics - Printed in Italy - All Rights Reserved  
STMicroelectronics GROUP OF COMPANIES

Australia - Brazil - Canada - China - Finland - France - Germany - Hong Kong - India - Israel - Italy - Japan - Malaysia - Malta - Morocco  
Singapore - Spain - Sweden - Switzerland - United Kingdom - United States.

© <http://www.st.com>