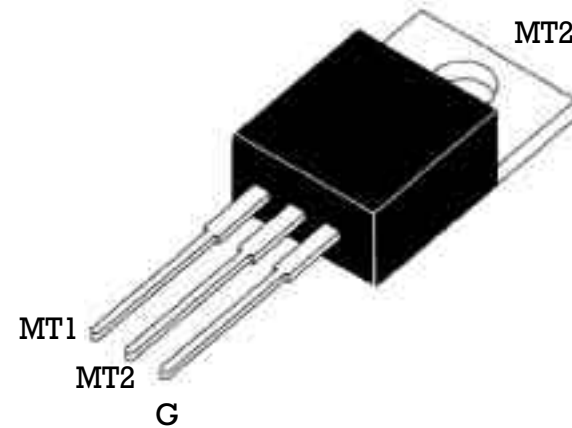

## HIGH COMMUTATION TRIAC

<p><b>TO220-AB</b></p> 	<p><b>On-State Current</b> 10 Amp</p> <p><b>Gate Trigger Current</b> 25 mA to 50 mA</p> <p><b>Off-State Voltage</b> 200 V ÷ 600 V</p>
<p>This series of <b>TRIAC</b>s uses a high performance PNP technology.</p> <p>These parts are intended for general purpose AC switching applications with highly inductive loads.</p>	

### Absolute Maximum Ratings, according to IEC publication No. 134

SYMBOL	PARAMETER	CONDITIONS	Min.	Max.	Unit
$I_{T(RMS)}$	RMS On-state Current	All Conduction Angle, $T_C = 105^\circ\text{C}$	10		A
$I_{TSM}$	Non-repetitive On-State Current	Full Cycle, 60 Hz	105		A
$I_{TSM}$	Non-repetitive On-State Current	Full Cycle, 50 Hz	100		A
$I^2t$	Fusing Current	$t_p = 10\text{ ms}$ , Half Cycle	55		A <sup>2</sup> s
$I_{GM}$	Peak Gate Current	$20\ \mu\text{s max.}$ $T_j = 125^\circ\text{C}$		4	A
$P_{G(AV)}$	Average Gate Power Dissipation	$T_j = 125^\circ\text{C}$		1	W
$di/dt$	Critical rate of rise of on-state current	$I_G = 2 \times I_{GT}$ , $t_r = 100\text{ns}$ $f = 120\text{ Hz}$ , $T_j = 125^\circ\text{C}$	50		A/ $\mu\text{s}$
$T_j$	Operating Temperature		-40	+125	$^\circ\text{C}$
$T_{stg}$	Storage Temperature		-40	+150	$^\circ\text{C}$

SYMBOL	PARAMETER	VOLTAGE			Unit
		B	D	M	
$V_{DRM}$	Repetitive Peak Off State Voltage	200	400	600	V
$V_{RRM}$					

## HIGH COMMUTATION TRIAC

### Electrical Characteristics

SYMBOL	PARAMETER	CONDITIONS	Quadrant		SENSITIVITY			Unit
					11	14	16	
$I_{CT}^{(1)}$	Gate Trigger Current	$V_D = 12 V_{DC}, R_L = 33 \Omega, T_j = 25^\circ C$	Q1÷Q3	MAX	25	35	50	mA
$I_{DRM} / I_{RRM}$	Off-State Leakage Current	$V_D = V_{DRM}, T_j = 125^\circ C$		MAX	1			mA
		$V_R = V_{RRM}, T_j = 25^\circ C$		MAX	5			$\mu A$
$V_{to}^{(2)}$	Threshold Voltage	$T_j = 125^\circ C$		MAX	0.85			V
$R_d^{(2)}$	Dynamic Resistance	$T_j = 125^\circ C$		MAX	40			m
$V_{TM}^{(2)}$	On-state Voltage	$I_T = 14 \text{ Amp}, t_p = 380 \mu s, T_j = 25^\circ C$		MAX	1.55			V
$V_{GT}$	Gate Trigger Voltage	$V_D = 12 V_{DC}, R_L = 33 \Omega, T_j = 25^\circ C$	Q1÷Q3	MAX	1.3			V
$V_{GD}$	Gate Non Trigger Current	$V_D = V_{DRM}, R_L = 3.3K \Omega, T_j = 125^\circ C$	Q1÷Q3	MIN	0.2			V
$I_H^{(2)}$	Holding Current	$I_T = 500 \text{ mA}, \text{ Gate open}, T_j = 25^\circ C$		MAX	25	35	50	mA
$I_L$	Latching Current	$I_G = 1.2 I_{CT}, T_j = 25^\circ C$	Q1,Q3	MAX	40	50	70	mA
			Q2	MAX	50	60	80	
$dv / dt^{(2)}$	Critical Rate of Voltage Rise	$V_D = 0.67 \times V_{DRM}, \text{ Gate open}, T_j = 125^\circ C$		MIN	200	500	1000	V/ $\mu s$
$(dI/dt)_c^{(2)}$	Critical Rate of Current Rise	$(dv/dt)_c = 0.1 \text{ V}/\mu s, T_j = 125^\circ C$		MIN	-	-	-	A/ms
		$(dv/dt)_c = 10 \text{ V}/\mu s, T_j = 125^\circ C$		MIN	-	-	-	
		without snubber, $T_j = 125^\circ C$		MIN	5	5.5	9	
$R_{th(j-c)}$	Thermal Resistance Junction-Case	for AC 360° conduction angle			1.5			$^\circ C/W$
$R_{th(j-a)}$	Thermal Resistance Junction-Ambient				60			$^\circ C/W$

(1) Minimum  $I_{CT}$  is guaranteed at 5% of  $I_{CT}$  max.

(2) For either polarity of electrode MT2 voltage with reference to electrode MT1.

### PART NUMBER INFORMATION

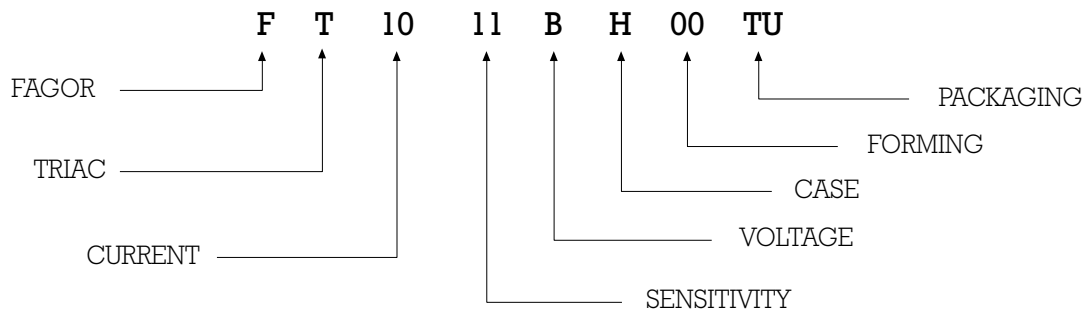

# HIGH COMMUTATION TRIAC

Fig. 1: Maximum power dissipation versus RMS on-state current (full cycle).

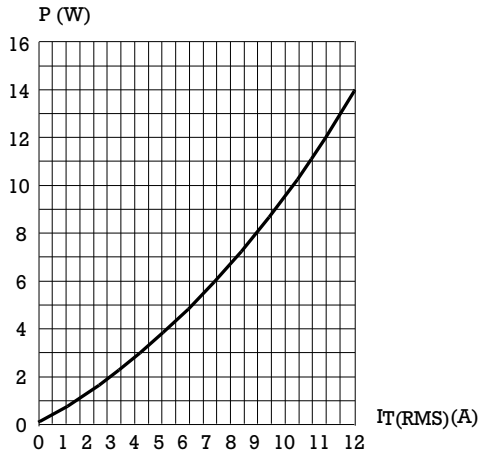

Fig. 2: RMS on-state current versus case temperature (full cycle).

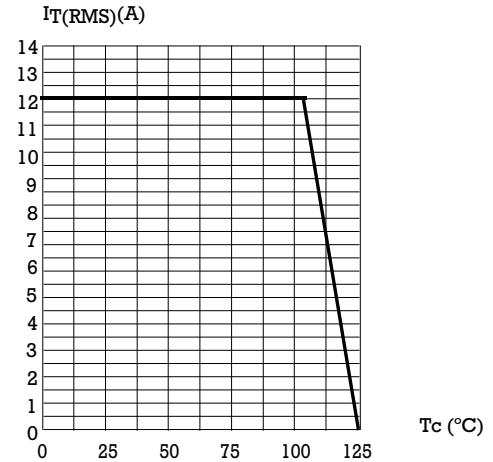

Fig. 3: Relative variation of thermal impedance versus pulse duration.

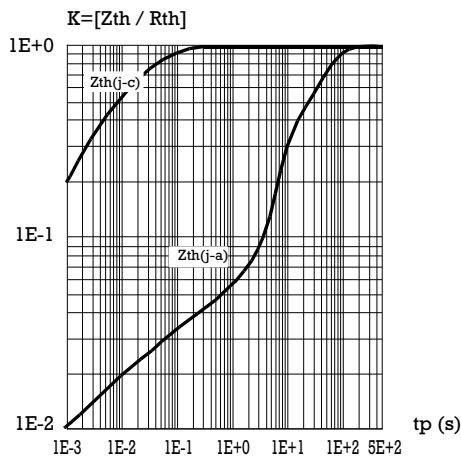

Fig. 4: On-state characteristics (maximum values)

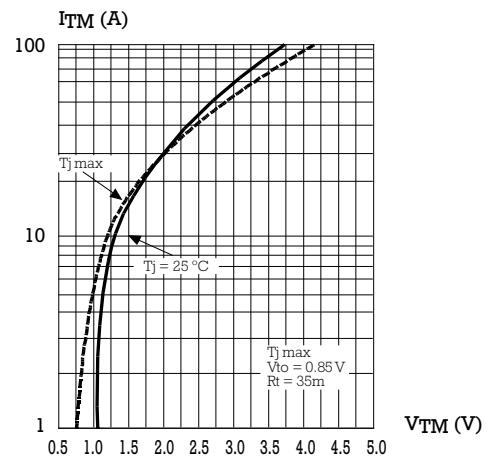

Fig. 5: Surge peak on-state current versus number of cycles

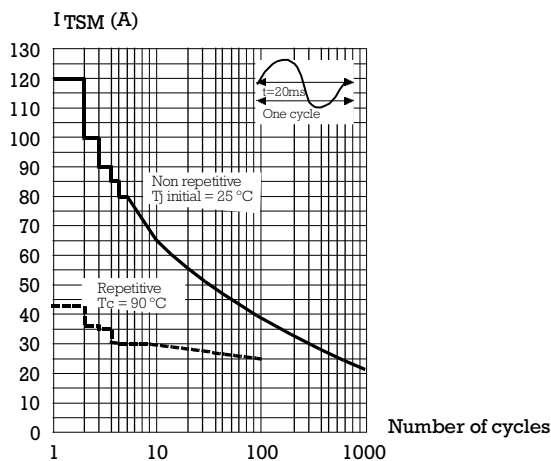
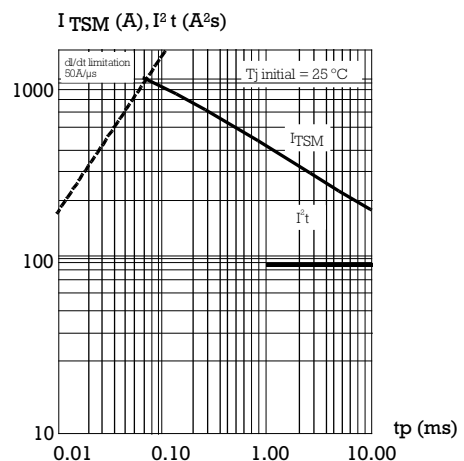

Fig. 6: Non-repetitive surge peak on-state current for a sinusoidal pulse with width  $t_p < 10\text{ms}$ , and corresponding value of  $I^2 t$ .



## HIGH COMMUTATION TRIAC

Fig. 7: Relative variation of gate trigger current, holding current and latching current versus junction temperature (typical values)

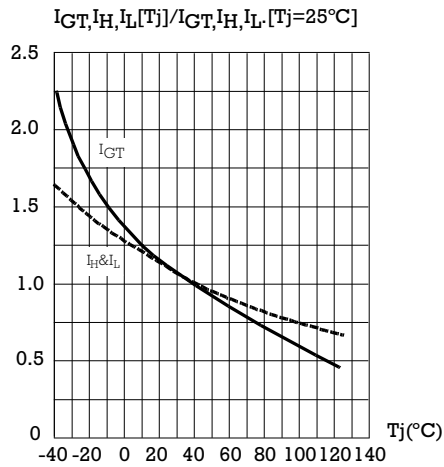
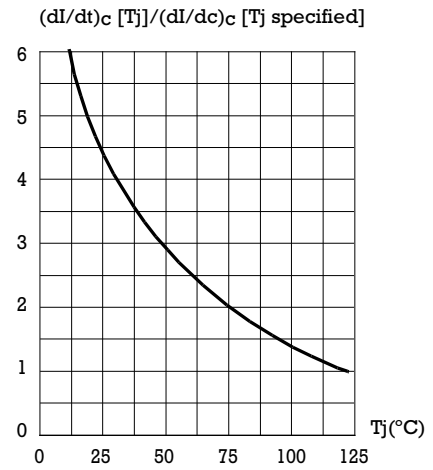

Fig. 8: Relative variation of critical rate of decrease of main current versus junction temperature



### PACKAGE MECHANICAL DATA TO-220AB (Plastic)

